

DATA SHEET

Product Name Wide Terminal Thick Film Chip Resistors

Part Name WR Series

File No. SMD-SP-010

Uniroyal Electronics Global Co., Ltd.

88#, Longteng Road, Economic & Technical Development Zone, Kunshan, Jiangsu, China

Tel +86 512 5763 1411 / 22 /33

Email marketing@uni-royal.cn

Manufacture Plant Uniroyal Electronics Industry Co., Ltd.

Aeon Technology Corporation

Royal Electronic Factory (Thailand) Co., Ltd.

Royal Technology (Thailand) Co., Ltd.

1. Scope

- 1.1 This data sheet is the characteristics of Wide Terminal Thick Film Chip Resistors manufactured by UNI-ROYAL.
- 1.2 Suitable for both wave & re-flow soldering
- 1.3 Application: AV adapters, LCD back-light, camera strobe etc
- 1.4 AEC-Q200 qualified
- 1.6 Compliant with RoHS directive.
- 1.7 Halogen free requirement.

2. Part No. System

Part No. includes 14 codes shown as below:

2.1 1st~4th codes: Part name. E.g.: WR08, WR12, WR20, WR18, WR25

2.2 5th~6th codes: Power rating.

E.g.: W=Normal Size	“1~G” = “1~16”					
Wattage	1/2	1/3	2/3	1	2	3
Normal Size	W2	W3	WK	1W	2W	3W

If power rating is equal or lower than 1 watt, 5th code would be “W” and 6th code would be a number or letter.

E.g.: W2=1/2W W3=1/3W

2.3 7th code: Tolerance. E.g.: D=±0.5% F=±1% G=±2% J=±5% K= ±10%

2.4 8th~11th codes: Resistance Value.

2.4.1 If value belongs to standard value of E-24 series, the 8th code is zero, 9th~10th codes are the significant figures of resistance value, and the 11th code is the power of ten.

2.4.2 If value belongs to standard value of E-96 series, the 8th~10th codes are the significant figures of resistance value, and the 11th code is the power of ten.

2.4.3 11th codes listed as following:

0=10⁰ 1=10¹ 2=10² 3=10³ 4=10⁴ 5=10⁵ 6=10⁶ J=10⁻¹ K=10⁻² L=10⁻³ M=10⁻⁴

2.5 12th~14th codes.

2.5.1 12th code: Packaging Type. E.g.: C=Bulk T=Tape/Reel

2.5.2 13th code: Standard Packing Quantity.

4=4,000pcs 5=5,000pcs C=10,000pcs D=20,000pcs E=15,000pcs

Chip Product: BD=B/B-20000pcs TC=T/R-10000pcs

2.5.3 14th code: Special features.

E = Environmental Protection, Lead Free, or Standard type.

3. Ordering Procedure

(Example: WR12 1W ±1% 0.33Ω T/R-5000)

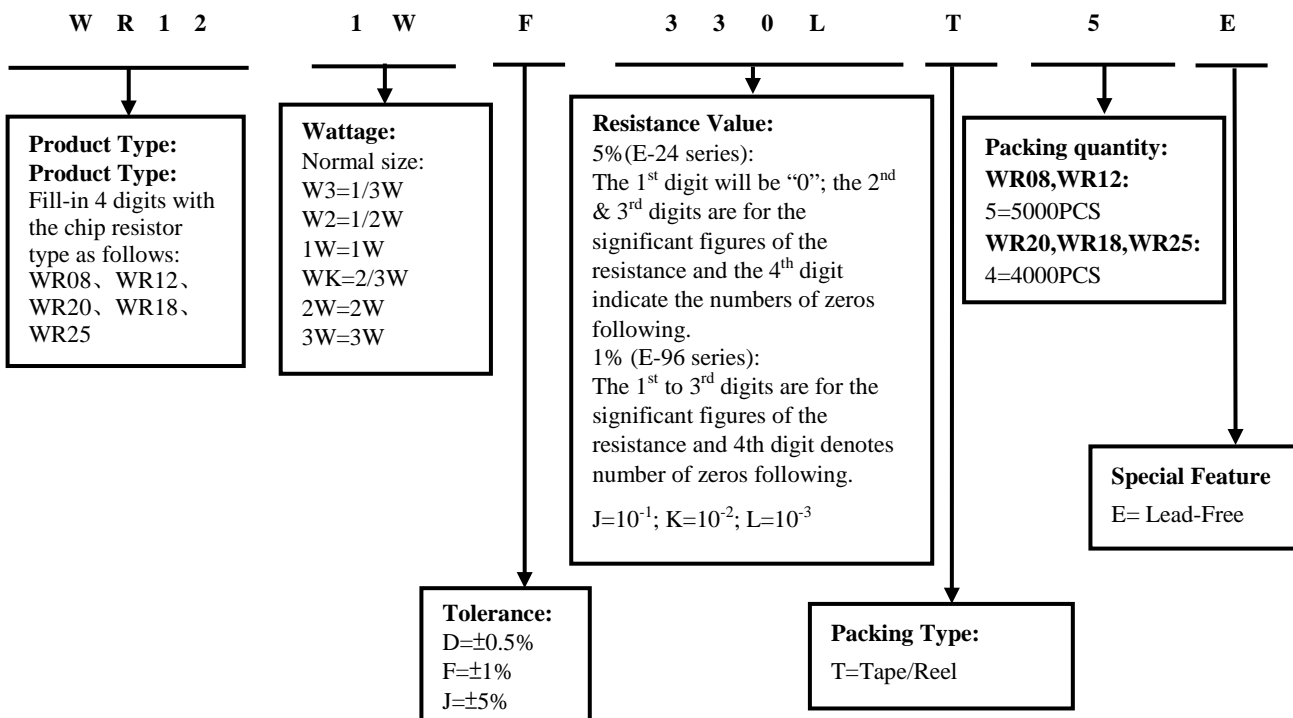

4. Marking

4.1 ±5% tolerance products (E-24 series):

3 codes.

1st~2nd codes are the significant figures of resistance value, and the rest code is the power of ten.

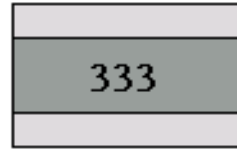

333 → 33KΩ

4.2 ±5% Tolerance: Below 10Ω show as following, read alphabet "R" as decimal point.

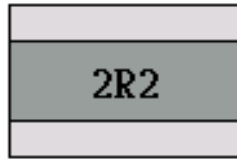

2R2 → 2.2Ω

4.3 ±1% tolerance products (E-96 series):

4 codes.

1st~3rd codes are the significant figures of resistance value, and the rest code is the power of ten.

Letter "R" in mark means decimal point.

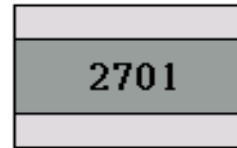

2701 → 2.7KΩ

4.4 ±5%, ±1%, ±0.5% Tolerance, Product below 1Ω, show as following, the first digit is "R" which as decimal point.

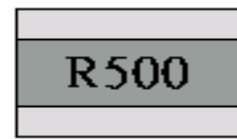

R500 → 0.5Ω

5. Dimension

Type	Dimension(mm)				
	L	W	H	A	B
WR08(0508)	1.20±0.10	2.0±0.10	0.55±0.10	0.20±0.10	0.30±0.20
WR12(0612)	1.60±0.15	3.20±0.15	0.55±0.10	0.30±0.20	0.45±0.20
WR20(1020)	2.50±0.15	5.00±0.15	0.55±0.10	0.40±0.20	0.60±0.20
WR18(1218)	3.10±0.10	4.60±0.15	0.55±0.10	0.45±0.20	0.40±0.20
WR25(1225)	3.10±0.15	6.25±0.15	0.55±0.10	0.45±0.20	0.65±0.20

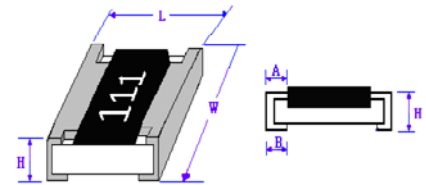

6. Resistance Range

Type	Power Rating	Resistance Range	
		±0.5%, ±1%	±5%
WR08	2/3W	10mΩ ≤ R < 10Ω	
	1/3W	10Ω ≤ R ≤ 1M	
WR12	1W	10mΩ ≤ R ≤ 1KΩ	
	1/2W	1KΩ < R ≤ 1M	
WR20	1W	10m ≤ R < 1Ω	
		1Ω, 10Ω ≤ R ≤ 1M	1Ω ≤ R ≤ 1M
WR18	1W	10mΩ ≤ R ≤ 1M	
WR25	3W	10mΩ ≤ R ≤ 1Ω	
	2W	1Ω < R ≤ 1M	

7. Ratings

Type	Max Working Voltage	Max Overload Voltage	Dielectric Withstanding Voltage	Resistance Value of Jumper	Rated Current of Jumper	Max. Overload Current of Jumper	Operating Temperature
WR08	150V	300V	500V	< 50mΩ	4A	8A	-55°C~155°C
WR12	200V	400V	500V	< 50mΩ	5A	10A	-55°C~155°C
WR20	200V	400V	500V	< 50mΩ	6A	12A	-55°C~155°C
WR18	200V	400V	500V	< 50mΩ	6A	10A	-55°C~155°C
WR25	200V	400V	500V	< 50mΩ	6A	15A	-55°C~155°C

8. Soldering pad size recommended

Type	Dimension(mm)			
	A	B	C	D
WR08	0.5±0.1	1.0±0.1	2.0±0.1	2.7±0.1
WR12	0.6±0.1	1.0±0.1	3.2±0.1	2.9±0.1
WR20	1.1±0.1	1.2±0.1	5.0±0.1	3.5±0.1
WR18	2.2±0.1	1.2±0.1	4.6±0.1	4.6±0.1
WR25	1.4±0.1	1.3±0.1	6.4±0.1	4.0±0.1

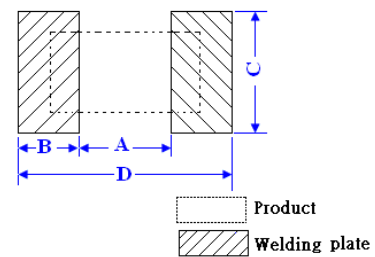

9. Derating Curve

Power rating will change based on continuous load at ambient temperature from -55 to 155°C. It is constant between -55 to 70°C, and derate to zero when temperature rise from 70 to 155°C.

Voltage rating:

Resistors shall have a rated direct-current (DC) continuous working voltage or an approximate sine-wave root-mean-square (RMS) alternating-current (AC) continuous working voltage at commercial-line frequency and waveform corresponding to the power rating, as determined from the following formula:

$$RCWV = \sqrt{P \times R}$$

Remark: RCWV: Rating Continuous Working Voltage (Volt.) P: power rating (Watt) R: nominal resistance (Ω)

In no case shall the rated DC or RMS AC continuous working voltage be greater than the applicable maximum value.

The overload voltage is 2.5 times RCWV or Max. Overload voltage whichever is lower.

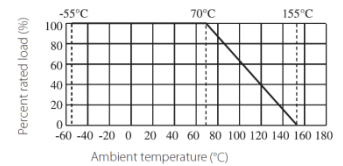

10. Structure

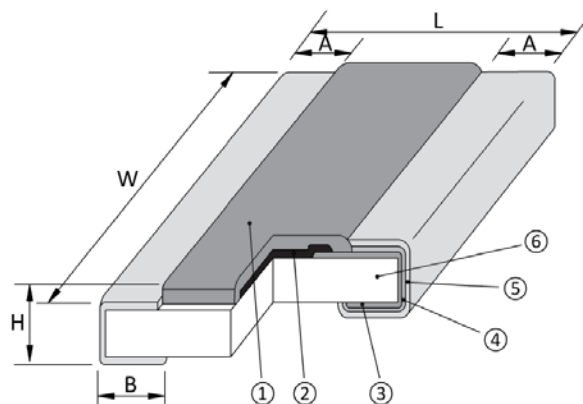

1. Protective layer
2. Resistive element
3. Termination (Inner) Ni / Cr
4. Termination (Between) Ni
5. Termination (Outer) Sn
6. High purity Alumina substrate

11. Performance Specification

Characteristic	Limits	Ref. Standards	Test Methods
Operational life	±0.5%,±1% : ±(1.0%+0.005Ω) ±5% : ±(3.0%+0.005Ω)	MIL-STD-202	125°C, at 36% of operating power, 1000H(1.5 hours “ON”, 0.5 hour “OFF”).
	For Jumper : <100mΩ		Apply to rate current for 0 Ω
Electrical Characterization	<p>WR08: 10mΩ ≤ R < 30mΩ : 0~+400PPM/°C 30mΩ ≤ R < 1Ω : 0~+150PPM/°C 1Ω ≤ R ≤ 100Ω : ±200PPM/°C >100Ω : ±100PPM/°C</p> <p>WR12: 10mΩ ≤ R < 100mΩ: 0~+200PPM/°C 100mΩ ≤ R < 1Ω : 0~+150PPM/°C 1Ω ≤ R ≤ 100Ω : ±200PPM/°C >100Ω : ±100PPM/°C</p> <p>WR20: 10mΩ ≤ R < 30mΩ : 0~+200PPM/°C 30mΩ ≤ R < 1Ω : 0~+100PPM/°C 1Ω ≤ R ≤ 100Ω : ±200PPM/°C >100Ω : ±100PPM/°C</p> <p>WR18: 10mΩ ≤ R < 30mΩ: 0~+200PPM/°C 30mΩ ≤ R < 1Ω : 0~+100PPM/°C 1Ω ≤ R ≤ 100Ω : ±200PPM/°C >100Ω: ±100PPM/°C</p> <p>WR25: 10mΩ ≤ R < 30mΩ : 0~+150PPM/°C 30mΩ ≤ R < 1Ω : 0~+100PPM/°C 1Ω ≤ R ≤ 100Ω : ±200PPM/°C >100Ω: ±100PPM/°C</p>	GB/T 5729 4.8 JIS-C-5201 4.8 IEC60115-1 4.8	<p>4.8 Natural resistance changes per temp. Degree centigrade</p> $\frac{R_2 - R_1}{R_1(t_2 - t_1)} \times 10^6 \text{ (PPM/°C)}$ <p>R₁: Resistance Value at room temperature (t₁) ; R₂: Resistance at test temperature (t₂) t₁: +25°C or specified room temperature t₂: Test temperature (-55°C or 125°C)</p>
Short-time overload	±0.5%,±1% : ±(1.0%+0.005Ω) ±5% : ±(2.0%+0.005 Ω)	GB/T 5729 4.13 JIS-C-5201 4.13 IEC60115-1 4.13	4.13 Permanent resistance change after the application of a potential of 2.5 times RCWV or Max.Overload Votage whichever less for 5 seconds.
	For Jumper : <50mΩ		Apply max Overload current for 0Ω
External Visual	No Mechanical Damage	MIL-STD-883 Method 2009	Electrical test not required. Inspect device construction, marking and workmanship
Physical Dimension	Reference 5 Dimension Standards	JESD22 MH Method JB-100	Verify physical dimensions to the applicable device detail specification. Note: User(s) and Suppliers spec. Electrical test not required.
Resistance to Solvent	Marking Unsmearred	MIL-STD-202 Method 215	Note: Add Aqueous wash chemical – OKEM Clean or equivalent. Do not use banned solvents.
Terminal Strength	Not broken	JIS-C-6429	Force of 1.8kg for 60 seconds.
High Temperature Exposure (Storage)	±0.5%,±1% : ±(1.0%+0.005Ω) ±5% : ±(3.0%+0.005Ω)	MIL-STD-202 Method 108	1000hrs. @T=155°C. Unpowered. Measurement at 24±2 hours after test conclusion.
	For Jumper : <50mΩ		
Temperature Cycling	±(1.0%+0.005Ω)	JESD22 Method JA-104	1000 Cycles (-55°C to +155°C). Measurement at 24±2 hours after test conclusion.
	For Jumper : <50mΩ		
Biased Humidity	±0.5%,±1% : ±(1.0%+0.005Ω) ±5% : ±(3.0%+0.005Ω)	MIL-STD-202 Method 103	1000 hours 85°C, 85%RH. Note: Specified conditions: 10% of operating power. Measurement at 24±2 hours after test conclusion.
	For Jumper : <100mΩ		Apply to rate current for 0 Ω

Mechanical Shock	$\pm 0.5\%, \pm 1\%: \pm(1.0\%+0.005\Omega)$ $\pm 5\%: \pm(2.0\%+0.005\Omega)$	MIL-STD-202 Method 213	Wave Form: Tolerance for half sine shock pulse. Peak value is 100g's. Normal duration (D) is 6.
	For Jumper : <50m Ω		
Vibration	$\pm 0.5\%, \pm 1\%: \pm(1.0\%+0.005\Omega)$ $\pm 5\%: \pm(2.0\%+0.005\Omega)$	MIL-STD-202 Method 204	5g's for 20 min., 12cycle each of 3 orientations. Note: Use 8''*5''PCB. 031'' thick 7 secure points on one long side and 2 secure points at corners of opposite sides. Parts mounted within 2' from any secure point. Test from 10-2000Hz.
	For Jumper : <50m Ω		
ESD	$\pm(3.0\%+0.005\Omega)$	AEC-Q200-002	With the electrometer in direct contact with the discharge tip, verify the voltage setting at levels of $\pm 500V, \pm 1KV, \pm 2KV, \pm 4KV, \pm 8KV$, The electrometer reading shall be within $\pm 10\%$ for voltages from 500V to $\leq 800V$.
	For Jumper : <50m Ω		
Solderability	Coverage must be over 95%.	J-STD-002	For both leaded & SMD. Electrical test not required. Magnification 50X. Conditions: a) Method B 4hrs at 155 $^{\circ}C$ dry heat, the dip in bath with 245 $\pm 3^{\circ}C, 5 \pm 0.5s$. b) Method D: at 260 $\pm 3^{\circ}C, 30 \pm 0.5s$.
Flammability	No ignition of the tissue paper or scorching or the pinewood board	UL-94	V-0 or V-1 are acceptable. Electrical test not required.
Board Flex	$\pm(1\%+0.005\Omega)$	JIS-C-6429	2mm (Min)
	For Jumper : <50m Ω		
Flame Retardance	No flame	AEC-Q200-001	Only requested, when voltage/power will increase the surface temp to 350 $^{\circ}C$. Apply voltage from 9V to 32V. No flame; No explosion.
Resistance to Soldering Heat	$\pm(1.0\%+0.005\Omega)$	MIL-STD-202 Method 210	Condition B No per-heat of samples. Dipping the resistor into a solder bath having a temperature of 260 $^{\circ}C \pm 5^{\circ}C$ and hold it for 10 ± 1 seconds
	For Jumper : <50m Ω		

12. Soldering Condition

(This is for recommendation, please customer perform adjustment according to actual application)

12.1 Recommend Reflow Soldering Profile : (solder : Sn96.5 / Ag3 / Cu0.5)

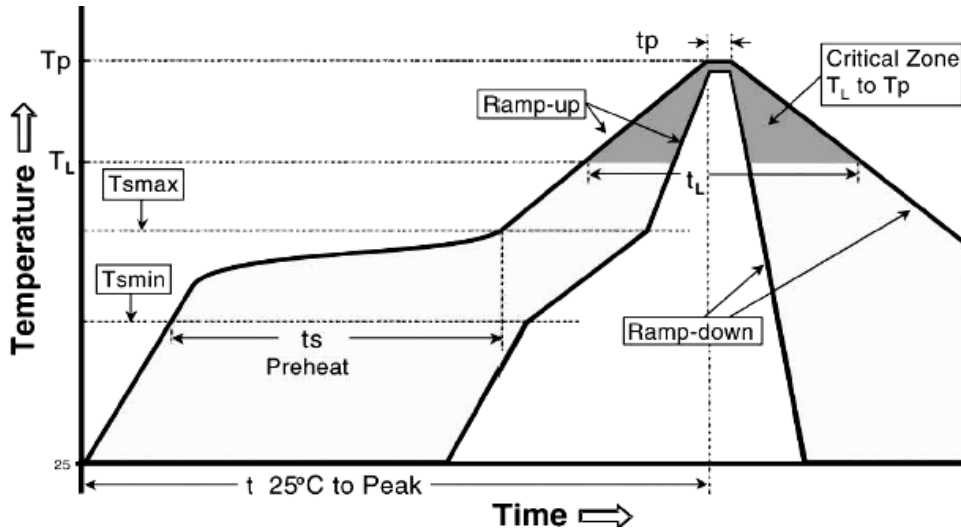

Profile Feature	Lead (Pb)-Free solder
Preheat: Temperature Min ($T_{s_{min}}$) Temperature Max ($T_{s_{max}}$) Time ($T_{s_{min}}$ to $T_{s_{max}}$) (t_s)	150°C 200°C 60 -120 seconds
Average ramp-up rate: (T_s max to T_p)	3°C / second max.
Time maintained above : Temperature (T_l) Time (t_l)	217°C 60-150 seconds
Peak Temperature (T_p)	260°C
Time within $+0$ -5 °C of actual peak Temperature (t_p) ²	10 seconds
Ramp-down Rate	6°C/second max.
Time 25°C to Peak Temperature	8minutes max.

Allowed Re-flow times : 2 times

Remark : To avoid discoloration phenomena of chip on terminal electrodes, we suggest use N₂ Re-flow furnace .

12.2 Recommend Wave Soldering Profile : (Apply to 0603 and above size)

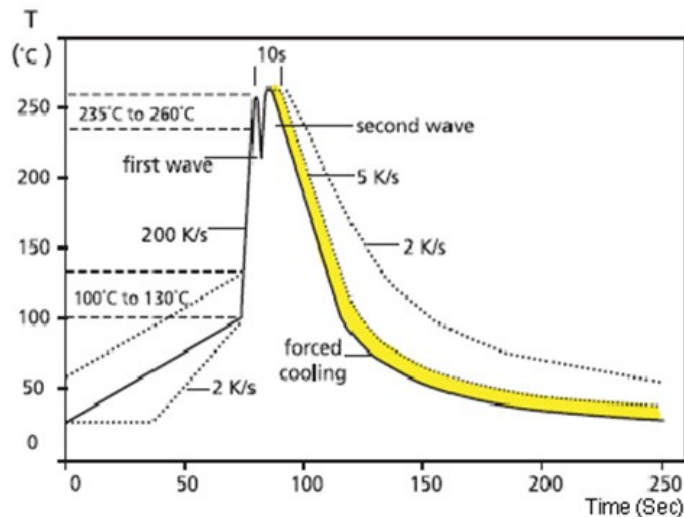

13. Packing of Surface Mount Resistors

13.1 Dimension of Paper Taping : (Unit: mm)

Type	A ±0.2	B ±0.2	C ±0.05	$\Phi D_{-0}^{+0.1}$	E ±0.1	F ±0.05	G ±0.1	W ±0.2	T ±0.1
WR08	1.65	2.40	2.0	1.5	1.75	3.5	4.0	8.0	0.81
WR12	2.00	3.60	2.0	1.5	1.75	3.5	4.0	8.0	0.81

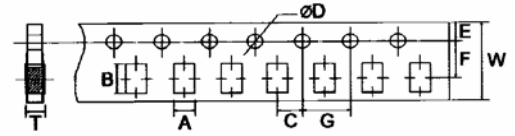

13.2 Dimension of plastic taping: (Unit: mm)

Type	A ±0.2	B ±0.2	C ±0.05	$\Phi D_{-0}^{+0.1}$	$\Phi D1_{-0}^{+0.25}$	E ±0.1	F ±0.05	G ±0.1	W ±0.2	T ±0.1
WR20	2.9	5.6	2.0	1.5	1.5	1.75	5.5	4.0	12	1.0
WR18	3.5	4.8	2.0	1.5	1.5	1.75	5.5	4.0	12	1.0
WR25	3.5	6.7	2.0	1.5	1.5	1.75	5.5	4.0	12	1.0

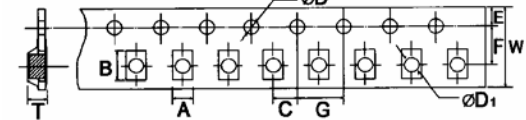

13.3 Dimension of Reel : (Unit: mm)

Type	Taping	Qty/Reel	A±0.5	B±0.5	C±0.5	D±1	M±2	W±1
WR08	Paper	5,000pcsl	2.0	13.0	21.0	60.0	178	10
WR12	Paper	5,000pcs	2.0	13.0	21.0	60.0	178	10
WR20	Embossed	4,000pcs	2.0	13.0	21.0	60.0	178	13.8
WR18	Embossed	4,000pcs	2.0	13.0	21.0	60.0	178	13.8
WR25	Embossed	4,000pcs	2.0	13.0	21.0	60.0	178	13.8

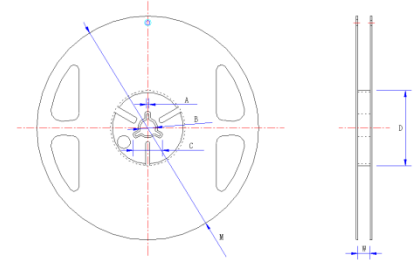

14. Note

- 14.1. UNI-ROYAL recommend products store in warehouse with temperature between 15 to 35°C under humidity between 25 to 75%RH. Even under storage conditions recommended above, solder ability of products will be degraded stored over 1 year old.
- 14.2. Cartons must be placed in correct direction which indicated on carton, otherwise the reel or wire will be deformed.
- 14.3. Storage conditions as below are inappropriate:
 - a. Stored in high electrostatic environment
 - b. Stored in direct sunshine, rain, snow or condensation.
 - c. Exposed to sea wind or corrosive gases, such as Cl₂, H₂S, NH₃, SO₂, NO₂, Br etc.

15. Record

Version	Description	Page	Date	Amended by	Checked by
1	First version	1~8	Jun.17, 2020	Song Nie	Yuhua Xu
2	1.The power of WR12 10Ω~1KΩ is modified 2.Modify the Temperature Coefficient	3 5	Sep.17, 2022	Haiyan Chen	John Zhao
3	Modify Mechanical Shock、Vibration、ESD test	6	Feb.19, 2024	Song Nie	Haiyan Chen
4	Modify temperature cycling test	5	Aug.10, 2024	Haiyan Chen	Yuhua Xu
5	Add the ±0.5% tolerance	1~8	Nov.14, 2024	Haiyan Chen	Yuhua Xu

© Uniroyal Electronics Global Co., Ltd. All rights reserved. Specification herein will be changed at any time without prior notice